



EPROPULSION ELECTRIC BOATING

2022 10 Years of Innovation and
Customer Success





Contents

Why Electric P.04
Who We Are..... P.06
Partnership with SailGP P.14

Evo - Our Latest Innovation..... P.16
Product Range..... P.20
Versatile Applications..... P.21

Navy Series..... P.22
Spirit Series..... P.26
Pod Drive Series..... P.34
E-Series Lithium Battery..... P.36
Vaquita Motor..... P.40
Accessories..... P.44

Community Engagement..... P.48
ePropulsion Owner Group..... P.50
Ordering Information P.51

Why Electric



Better Experience

Quiet

It's virtually silent. Perfect for not spooking fish when you are fishing.

Clean

No messy fuel or oil leaks, and therefore no greasy stains on your hands, car trunk or boat.

Exhaust-Free

Keeping you, your family and friends safer and healthier.



Easier Operation

Reliable

The efficient and innovative motor structure means there are fewer moving parts - making it reliable and robust.

Digitization

Electric start and digital control with real-time operational data available.

Low Maintenance

Significantly lower maintenance required than combustion engines. Maintenance-free on direct drive models.



Kinder to the Earth

Renewable Energy Sources

Recharge with hydrogenation, wind turbine and solar panel.

Cost Effective

Save on fuel and maintenance costs which also creates more value to commercial boats over the long-term.

Environmentally Friendly

Enables boaters to access waters where combustion engines are banned.

Who We Are



Where we started

The idea was first started as a research project in the Hong Kong University of Science and Technology, a beautiful higher education institute located just by the bay and well-known for the breathtaking sea view. Out of the love for water sports and the ocean and a firm belief that ground-breaking electric engines and an innovative user-experience will accelerate human's transition into clean energy in the marine environment and beyond, four entrepreneurial engineering students started up the company ePropulsion. This young company was born to be an innovator and a change-maker with a strong drive to reconnect people with nature through better, smarter and cleaner inventions.

Where we are now

Growing from humble beginnings in 2012 to now a global leader in marine electric propulsion systems and services with a distribution network across over 60 countries and areas to date, and a workforce of over 250 around the globe, we are proud of the achievements we have made for the past ten years in driving the world's transition to electric boating. The brand is now recognized across the world for exceptional product quality, performance and technological innovation.

We will continue to pioneer new technologies as we move towards an exciting future.



We pride ourselves on being an innovator and market challenger

We have an established track record of cutting-edge design based on award-winning research and development. This led to the first introduction of a brushless direct drive electric outboard motor and the first incorporation of hydrogeneration capabilities into electric outboards in the industry.

ePropulsion has fast become a force to be reckoned with in the electric propulsion market, seeing the brand win significant market share across the world – which continues to grow.

The industry demand for ePropulsion products is set to propel even further.

Our Strengths

An underwater photograph showing the hull of a boat and a propeller. The water is clear and blue-green. The propeller has three blades and is mounted on a vertical shaft. The hull is white and has a curved shape. The lighting is bright, creating a shimmering effect on the water's surface.

Product Innovation

We constantly listen and talk to our customers, to fully understand their needs and to use their knowledge and feedback to help drive the continual innovation of our products. We are proud to say the end result is significantly better user experience than combustion engines or most comparable products.

Competitive Pricing

ePropulsion is helping to rapidly accelerate the transition to electric propulsion systems in boating and sailing communities. To help this transition, we supply products at competitive prices to help customers make the switch from combustion engines.

Quality Excellence

We collect and analyze quality-related historical and real-time data of our products and machinery in our manufacturing plant. We then utilize that data to build quality profiles and models. We have also built a QA laboratory which has 25 different testing capabilities that can simulate all extreme working and transportation conditions.

Fast Customer Service

Our wide and well-established network of dealers across 60+ countries and areas ensures that our customer support is fast and responsive. We are always there for you when you need it – making ownership of our products easy and hassle-free.

Technology Pioneer

ePropulsion has a strong engineering culture - it is in our DNA. Our engineers enjoy the toughest challenges and developing solutions and products that are truly innovative and easy-to-use.



Industry Leading

2021

The first hydroelectric outboard motors

Hydrogeneration function makes sailing more sustainable.

Model: Spirit 1.0 Evo | Navy 3.0 Evo | Navy 6.0 Evo



2014

The first brushless direct drive electric outboard motor

A direct drive outboard motor can be quiet, reliable and maintenance-free.

Model: Spirit 1.0



Engineering Innovation



Spirit Foldable Tiller

This makes transportation much easier. The tiller is always integrated with the Spirit motor, so it's quick to carry, pack and install. Competitor solution: Keep the tiller as a separate part. Assemble and detach it every time you need to use it.



Anti-Corrosion Technology

High-quality aluminum alloy is used as the basematerial. The surface is treated by sandblasting and a thick layer of anodizing coating is also applied. ePropulsion has completely eliminated corrosion on its products.



Floating Battery

The Spirit battery is the first floating battery on the market. With the waterproof and unsinkable design, users are worry-free and will never lose a battery overboard again.



Customer Satisfaction Matters the Most



“ Our focus every single day is to continually improve all aspects of our customer experience. ”

— Danny Tao
ePropulsion CEO & Co-Founder

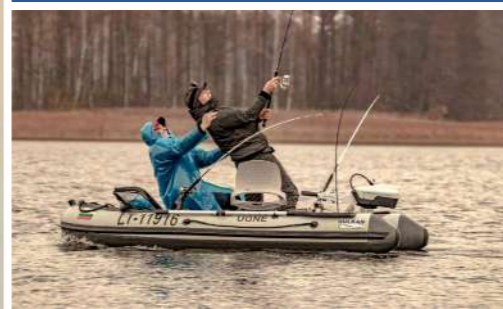

Customised Solutions Spirit 1.0 RS 21 Drive

“ You can usually expect some teething issues with new boat designs but the ePropulsion solution has been seamless. Their system works perfectly and is one of the easiest systems we fit on the boat, even when we are retrofitting on boats away from the factory. It's silent, robust and really complements the overall quality of the RS21 package.”

— Alex Southon, RS Sailing CEO 

On June 15, 2019, ePropulsion signed a deal to supply fully-integrated propulsion systems to RS Sailing. The new supply contract covers a bespoke mounting arrangement and integration of ePropulsion's Spirit 1.0 electric motor into a flush-fitting retractable electric drive system onboard the first 60 boats in RS Sailing's fleet of exciting new RS21 keelboat day racers.

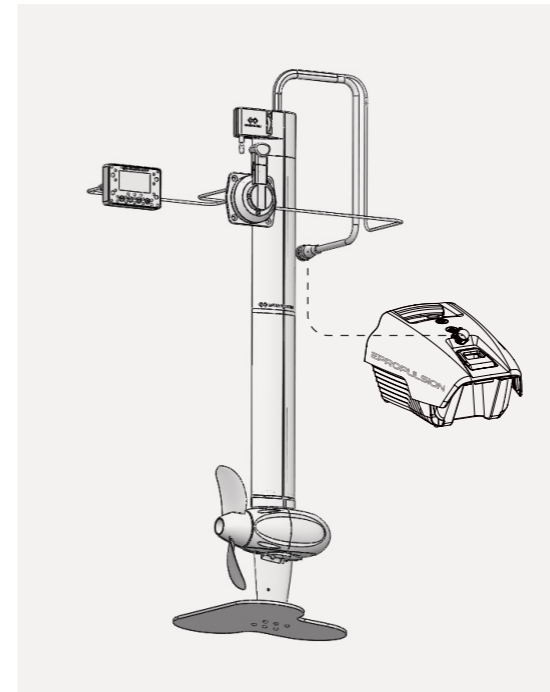



Partnering with SailGP to Advance Global Adoption of Clean Energy

SailGP is an adrenaline-fuelled global sailing competition and the first climate-positive sports and entertainment property with the goal of accelerating the transition to clean energy.

With a shared mission for more sustainability, ePropulsion is working in partnership with SailGP to provide 11 electric outboard motors for the league's event support tenders in Season 2 and Season 3. Both ePropulsion Spirit and Navy motors were selected to power SailGP Inspire support boats, the league's community engagement program.

ePropulsion and SailGP will continue to work together to help revolutionize the sports and entertainment industry focusing on an acceleration towards clean energy.



SailGP Support Boat Fleet Powered By



Spirit 1.0 Plus / 3HP



Navy 3.0 Evo / 6HP



E80 Battery / 4096 Wh

“

We are excited to work with like-minded partners that share our vision of accelerating the transition to clean energy. Our partnership with ePropulsion is the first of many steps to meet our ambitious target of being fully powered by nature on-water by 2025 and is a great example of how, through technology and innovation, we can help create a better planet.

”

- Fiona Morgan, SailGP Director of Purpose and Impact



EVO - OUR LATEST INNOVATION: SMARTER TECHNOLOGY BETTER USER EXPERIENCE



In 2021, ePropulsion launched seven all new Evo models. This is the most important product upgrade since the company delivered the first Spirit 1.0 seven years ago. The Evo upgrades are as a result of product feedback from our enthusiastic customers which has enabled us to closely refine and improve our range.



Hydrogeneration

ePropulsion's Spirit Evo and Navy Evo are the first-ever hydroelectric outboard motors. It's a remarkable green innovation, especially for the sailing community.

Benefit: Hydrogeneration makes sailing trips even more environmentally friendly and sustainable. Much of the time you don't even need to turn on the generator on a sailboat.



Safety Wristband

In case of a man overboard situation, the safety wristband immediately shuts down the motor. Each Evo motor can connect with up to 8 safety wristbands.

Benefit: The safety wristband keeps everyone onboard safe, not just the operator attached to the kill switch. This function also keeps you safe when you're alone and not in close proximity to the kill switch.



48V Motor Architecture

Each Evo model in the range has been developed on a 48V voltage platform with the same systems protocol.

Benefit: There is excellent compatibility between Evo outboards, Evo pod drives, E-Series batteries, and Evo controls - and therefore flexibility to configure a system that fits your needs.

Evo Controls



ePropulsion offers excellent compatibility between different control systems. They have all been developed under on same system platforms, and work seamlessly with Evo motors and other Evo components.



Evo Tiller

Ergonomic and removable design
3.4-in integrated display with backlight



Evo Remote Control

Wireless connection
3.4-in integrated display with backlight



Evo Side Mount Control

4.3-in separate display with backlight
False triggering protection



Evo Dual Remote Control

Sync Mode
Docking Mode
4.3-in separate display with backlight



Safety Wristband 2021 New

Easy-to-use and additional safety.

- Man overboard protection
- Wireless connection
- Waterproof IP67
- Max connection up to 8 wristbands per motor

To make your boating experience even safer, ePropulsion has launched its wireless safety wristband. In case of a man overboard situation, the safety wristband immediately shuts down the motor. Each Evo motor can connect with up to 8 safety wristbands. This function also keeps you safe when you're alone and not in close proximity to the kill switch. You, your families, friends, and dogs are all protected.

* Safety wristband is compatible with Evo tiller and Evo remote control, not compatible with Evo side mount control or Evo dual control.



Information Display

Keeping you informed.

- Battery level
- Remaining runtime
- Remaining distance*
- Realtime power
- Error codes
- Speed*
- Realtime voltage
- Hydrogeneration power / status
- Metric and imperial conversion
- Safety wristband connection status

* Not available on Spirit Series or Pod Drive 1.0 Evo.

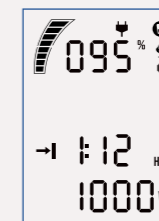



Product Range

Outboard

Navy 3.0 Evo
3 kW / 6 HP



Navy 6.0 Evo
6 kW / 9.9 HP



Spirit 1.0 Plus
1 kW / 3 HP



Spirit 1.0 Evo
1 kW / 3 HP



Spirit 1.0 Evo Remote
1 kW / 3 HP



Pod Drive

Pod Drive 1.0 Evo
1 kW / 3 HP



Pod Drive

Pod Drive 3.0 Evo
3 kW / 6 HP



Pod Drive 6.0 Evo
6 kW / 9.9 HP



Control

Evo Tiller



Evo Remote Control



Evo Side Mount Control



Evo Dual Remote Control



Battery

Spirit Battery Plus*
1276 Wh / 48 V



E40 Battery
2048 Wh / 48 V



E80 Battery
4096 Wh / 48 V



E175 Battery
8960 Wh / 48 V



* Also applicable to Spirit 1.0 Evo & Spirit 1.0 Evo Remote



Versatile Applications

For Sailboats

ePropulsion electric outboards enable one-design sailboats to leave and return to the marina quick, silent and maneuverable. Owners of daysailers and small cruising sailboats love pod drives because they are space-saving, quiet and vibration-free. The hydrogeneration and solar charging also allow sailors to travel further and sail sustainably.

For Fishing Boats

Fishing quiet is important. Our electric outboard motor is so quiet it won't spook the fish. In addition, electric outboards are super efficient at trolling speed and you can go fishing all day long without worrying about the run-time. Ideal for both freshwater and saltwater and perfect for jon boats, aluminum fishing boats, bass boats and fishing pontoons.

For Work Boats

The electric outboard motor has a simple structure and fewer components than gas engines. It offers a more reliable solution while requiring minimum maintenance. Work boats, commercial boats and rental boats can go further for longer. The quiet and exhaust-free experience also makes passengers comfortable onboard.

For Dinghy and Tenders

With our long-range batteries and digital display, boaters can leave their "run-time" worries on the dock. The integrated and maintenance-free designs are time- and money-saving, making our electric outboard motors perfect for dinghy, inflatable boats, tender boats and small sailboats.



Navy 3.0 Evo / 6HP

Navy 6.0 Evo / 9.9HP



Navy series electric outboard motors deliver nimble and efficient power at 6 HP or 9.9 HP depending on the model. Sleek, easy to use and eco-friendly, these outboards will be a staple of your boating experience for years to come.

Features

Brushless Direct Drive Motor

Navy series is a direct drive electric outboard at this power range. They're made of fewer moving parts, no gearbox required. This means less vibration, noise-free and high reliability.

Hydrogeneration

Both Navy 3.0 Evo and Navy 6.0 Evo feature hydrogeneration. Sailors will love this new feature. Only ePropulsion supplies electric outboard motors that have hydrogeneration functionality in the market.

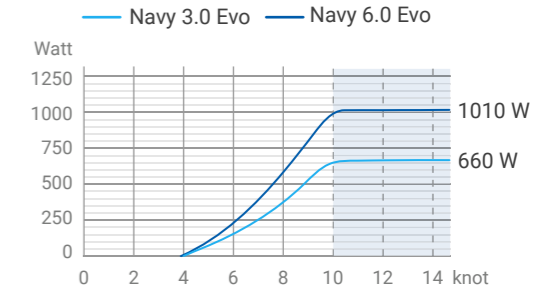

Specs



	Navy 3.0 Evo	Navy 6.0 Evo
Power	3 kW / 6 HP	6 kW / 9.9 HP
Operation Voltage	48V (Input Range 39V to 60V)	
Outboard Weight*	24.3 kg / 53.6 lbs	36 kg / 79.4 lbs
Shaft Length	S: 63.4 cm / 25 inches L: 75.9 cm / 29.9 inches	
Static Thrust	590 N / 132.6 lbs	1243 N / 279.4 lbs (13.4" x 8.5" composite propeller)
Propeller RPM	2300 RPM	1500 RPM
Propeller	10.2" x 6.7" 2-blade composite propeller	12.6" x 10.8" 3-blade composite propeller 13.4" x 8.5" 3-blade composite propeller 12.6" x 8.7" 3-blade aluminum propeller (optional)
Trim / Tilt Angle	0°, 5°, 10°, 15° / 60°	
Hydrogeneration*	✓	✓

* The outboard motor weight is measured with the short shaft version, excluding the control weight.

* The hydrogeneration data is based on real tests with the anticavitation plate installed. / Navy 6.0 Evo is tested with a 13.4" x 8.5" three-blade composite propeller.



Taking you Further

Performance & Range

Navy 3.0 Evo (Watt)	Speed (mph / kph)	Runtime (hh:mm)	Range (mile / km)	Navy 6.0 Evo (Watt)	Speed (mph / kph)	Runtime (hh:mm)	Range (mile / km)
300	3.7 / 6	13:20	49.3 / 79.3	500	4 / 6.5	18:00	72 / 116
550	4.7 / 7.5	7:25	35 / 56.3	1000	5 / 8	9:00	45 / 72
1000	5.3 / 8.6	4:00	21.2 / 34.1	2000	6.7 / 10.8	4:30	30.2 / 48.6
1500	6 / 9.7	2:40	16 / 25.7	3000	8 / 13	3:00	24 / 39
2000	6.3 / 10.2	2:00	12.6 / 20.4	4000	11.5 / 18.5	2:15	25.9 / 41.7
2500	8 / 12.8	1:35	12.7 / 20.5	5000	13.5 / 21.8	1:50	24.7 / 39.8
3000	10.2 / 16.4	1:20	13.6 / 21.9	6000	15 / 24.3	1:30	22.5 / 36.5

*The performance data is based on a 12-foot aluminum boat with one person, powered by one Navy 3.0 Evo and E80 battery / Navy 6.0 Evo and E175 battery in calm lake water. The actual speed, range and running time may vary because of different boats, load, weather, etc.

Go with Navy

Seattle

Pike Place Market to Golden Gardens Park

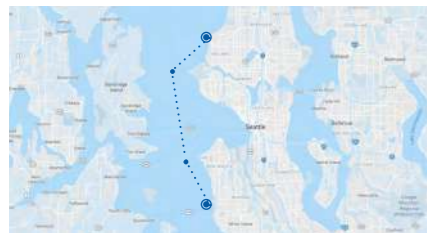

Navy 3.0 Evo + E80 = Round Trip / 24 Miles
Navy 6.0 Evo + E175 = Three Trips / 36 Miles

Miami

Miami Seaquarium to North Beach

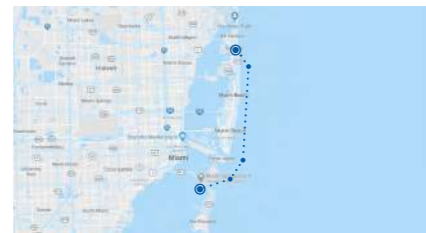

Navy 3.0 Evo + E80 = Round Trip / 22 Miles
Navy 6.0 Evo + E175 = Three Trips / 33 Miles

New York

Statue of Liberty to New York Aquarium



Navy 3.0 Evo + E80 = Round Trip / 22 Miles
Navy 6.0 Evo + E175 = Three Trips / 33 Miles

Navy 6.0 Evo Brings New Excitement

Highfield 380CL + Navy 6.0 Evo



“ I’m not used to feeling the water cavitating on the boat because usually you just feel the vibration of an engine. With Navy 6.0 Evo, it’s so quiet and so bizarre! It’s just the water under the hull. ”

- Captain Rick Moore

Captain Rick Moore has been sailing for over 20 years. He has always been led by his passion and the wind, and has been sharing his sailing and adventure stories for 15 years on YouTube channel Sophisticated Lady.

Follow Captain Rick Moore:

📷 Captain Rick Moore

📧 @sailingsophisticatedlady

📺 Sailing Sophisticated Lady

🌐 <https://www.sailingsophisticatedlady.com/>





SPIRIT SERIES

3HP / 1276Wh



Spirit 1.0 is ePropulsion's best selling series. It's designed for portability with a 1276 Wh integrated lithium battery.

Specs



	Spirit 1.0 Plus	Spirit 1.0 Evo	Spirit 1.0 Evo Remote
Power	1000W / 3HP		
Battery Capacity	1276 Wh		
Motor Weight*	10.6 kg / 23.4 lbs	11.3 kg / 24.9 lbs	10.9 kg / 24 lbs
Battery Weight	8.7 kg / 19.2 lbs		
Charging Time	3.5 Hrs (Fast charger) / 8.5 Hrs (Standard charger)		
Battery Life*	500 cycles at 80% DOD		
Shaft Length	XS: 52.5 cm / 20.7 inches S: 62.5 cm / 24.6 inches L: 75 cm / 29.5 inches	S: 62.5 cm / 24.6 inches L: 75 cm / 29.5 inches	
Input Voltage	39V - 60V		
Propeller RPM	1200 RPM		
Propeller	11" x 5.8" 2-blade composite propeller		
Trim / Tilt Angle	0°, 7°, 14°, 21° / 70°	0°, 7°, 14°, 21° / 85°	0°, 7°, 14°, 21° / 85°
Hydrogeneration	✗	✓	✓
Safety Wristband	✗	✓	✓
Display Backlight	✗	✓	✓

*The weight is measured by short shaft. The weight of Spirit 1.0 Evo Remote excludes the control.

*Battery life is based on laboratory testing. Actual battery life may vary depending on actual operational environment and usage conditions.

Taking you Further

Performance & Range

Power (Watt)	Speed (mph / kph)	Running Time (hh:mm)	Range (mile / km)
35	2.2 / 3.5	36:25	80 / 129
65	2.7 / 4.3	19:35	53 / 85.3
125	3.5 / 5.6	10:00	35 / 56
250	4.4 / 7.1	5:00	22 / 35.5
500	5.3 / 8.5	2:30	13.3 / 21.3
750	5.7 / 9.2	1:40	9.5 / 15.3
1000	6.2 / 10	1:15	7.8 / 12.5

*The performance data is based on a 12-foot aluminum boat with one person and one Spirit Battery Plus in calm lake water. The actual speed, range and running time may vary because of different boats, load, weather, etc.

Sailing Frenchman Loves Spirit 1.0 Evo



“ I really like the hydrogeneration feature. It’s been two weeks I have been using the engine, I haven’t charged it once on the plug, and it’s still 75%. ”

- Hugo, the Sailing Frenchman

One Charge to Go 22 Miles

Seattle

Pike Place Market to Golden Gardens Park
Round Trip / 18 Miles

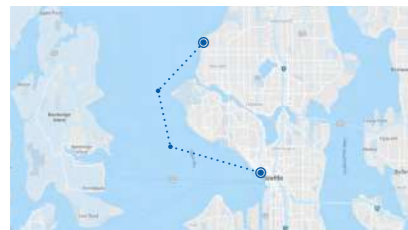

Miami

Miami Seaquarium to North Beach
Round Trip / 17.6 Miles

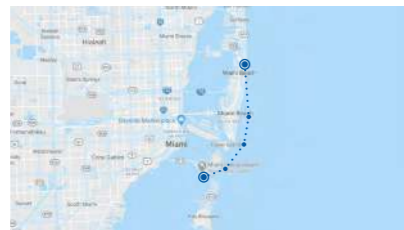

San Francisco

Golden Gate Bridge to Alcatraz Island to Pier 39
Two Laps / 16 Miles



Hugo, the owner of the popular Sailing Frenchman channel, has been a professional skipper and hired as the first mate for the Clipper Round the World Race since 2019. Since then, he has been training for the Mini Transat Race, a single-handed race across the Atlantic on the smallest offshore racing yacht - the Mini 6.50.



Follow Sailing Frenchman:

The Sailing Frenchman
 @thesailingfrenchman

The Sailing Frenchman
 <https://www.thesailingfrenchman.com/>



Long Range

Thanks to the 1276Wh large battery, Spirit 1.0 Plus / Evo has longer range than other gasoline outboards and electric outboards.

Spirit 1.0 Plus / Evo

75 min

Average 3HP electric outboard

50 min

A FourStroke 3.5HP*

48 min

* The runtime of the above FourStroke 3.5HP is measured with the 0.3 gal (1.1 L) internal fuel tank.

Hydrogeneration

Sailors will love this new feature. Only ePropulsion supplies electric outboard motors that have hydrogeneration functionality in the market.

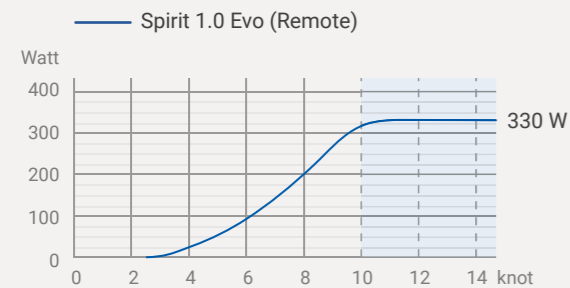

*The hydrogeneration data is based on real tests with the anti-ventilation plate installed.

Design

1 1 1 Magnetic kill switch

In case of emergency, pull out the switch to immediately stop the motor.

2 Removable tiller

Quick to install or pack your Spirit. Flexibility in carrying the tiller separately.

3 3 3 Gauge display

Access to battery level, remaining runtime, input power, and voltage, etc.

4 4 4 Charging port

It works with both AC charger and solar charger.

5 5 5 Durable metal connector

Made of stainless steel and processed by PVD technology.

6 6 Safety wristband

In case of man overboard, it immediately shuts down the motor.

7 Evo side mount control

This smooth single lever control works together with a 4.3-Inch gauge display.

8 Evo remote control

Compact, economical and integrated with a 3.4-Inch display.

9 9 9 Battery pull latch

Making battery installation easy and quick.

10 Steering tube

Works with a mechanical or hydraulic steering helm and the steering link arm.

11 11 11 Anti-corrosion coating

Anodized coating and powder coating which protects the base material from corrosion.





Spirit Battery



Floating Battery

Removing your battery to take it to and from your boat could mean accidentally dropping it in the water. That's why we developed the Spirit battery to float! You will never lose a battery overboard again.

Solar Charging

Using a solar panel, you can charge your battery up to 180 W while in use. On a sunny day, your battery could last all day if used at the economical power level. An additional benefit is that the solar panel is lightweight and foldable. An additional solar charger is required for this functionality.



Spirit Battery Power Output Set

In a non-deep-sleeping mode, extract the major power from the Spirit Battery to power other electronics on board, with a display of current battery level and error code. (note: the DC-DC connect to this needs to be purchased separately.)



Effortless Battery Replacement

To extend the range even further, you can purchase an additional Spirit battery. The battery is secured by a pull latch and changing out your battery usually takes less than 30 seconds. The process is very easy and it is good to know that storing your Spirit battery is safer than other fuels such as petrol/gasoline.





Pod Drive Series

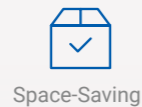
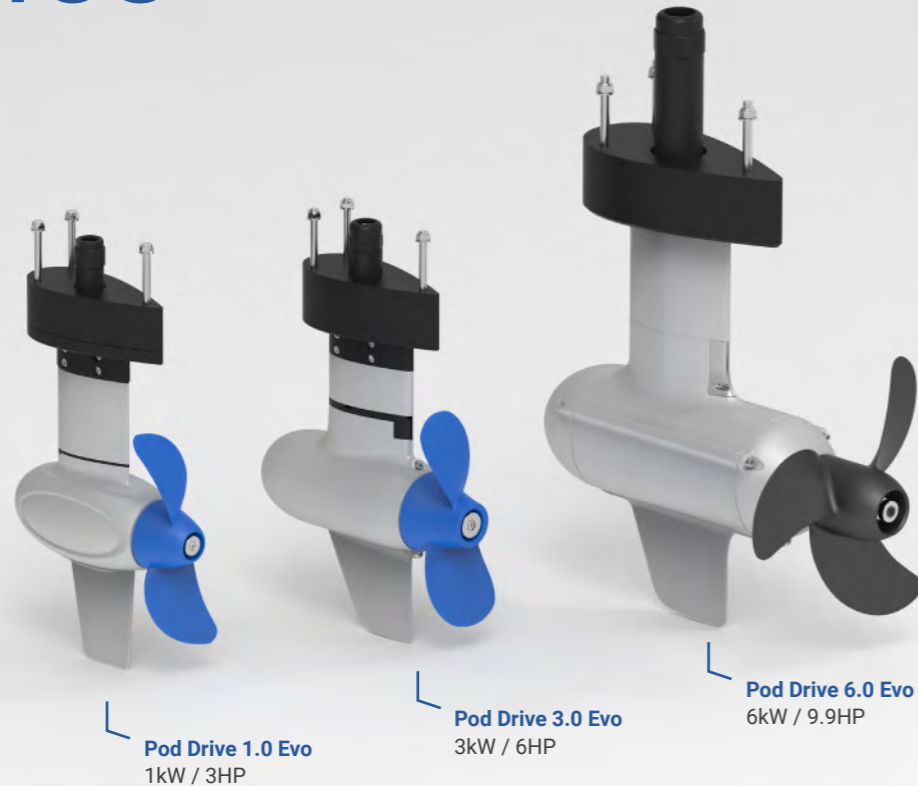

Space-Saving



Easy to Install



Quiet



Maintenance-Free

Hydrogeneration

Sailors will love the Evo series Pod Drive Series not just because they are lightweight and space-saving, but also because the hydrogeneration function brings more flexibility and sustainability to their sailing activities by converting sustainable energy of water flow into electricity for batteries.

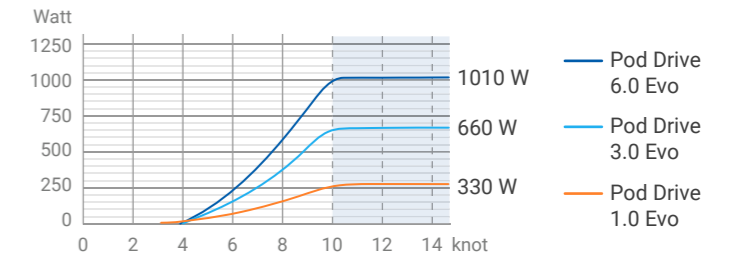

Specs



	Pod Drive 1.0 Evo	Pod Drive 3.0 Evo	Pod Drive 6.0 Evo
Power	1 kW / 3 HP	3 kW / 6 HP	6 kW / 9.9 HP
Operation Voltage	48V (Input Range 39V to 60V)		
Weight	6.2 kg / 13.7 lbs	15.3 kg / 33.7 lbs	31kg / 68.3 lbs
Static Thrust	316 N / 71 lbs	590 N / 132.6 lbs	1080 N / 242.8 lbs
Propeller RPM	1200 RPM	2300 RPM	1500 RPM
Propeller	11" x 5.8" 2-blade composite propeller	10.2" x 6.7" 2-blade composite propeller	12.6" x 8.7" 3-blade aluminum propeller / 12" x 21.3" 2-blade NAB folding propeller(optional)
Hydrogeneration	✓	✓	✓

*The weight includes the driver unit.



E-Series Lithium Battery

Affordable, safe and durable LiFePO4 batteries for ePropulsion motors.



Overview

To ensure the best customer experience by eliminating compatibility issues, it is important to supply batteries that work efficiently with ePropulsion boat motors. Our solution is the 48V E-Series battery that works seamlessly with every 48V ePropulsion motor. The lithium iron phosphate chemistry is both safe and stable. It retains over 80% capacity after 3,000 cycles at 80% DoD. The compact size makes it flexible and easy to be use in a wide range of different boats.

Why Choose E-Series Battery



Affordable cost

Unit price is as low as \$0.5 per watt-hour.



Long life cycles

3000 cycles at 80% DoD.



High energy density

70% less weight and space than a normal lead-acid battery.



Made for ePropulsion motors

Data is synced with ePropulsion motors to allow a smart operation strategy.



Data accuracy

ePropulsion batteries are designed for maximum efficiency, performance and safety. They allow for the use of our communication cable which brings data accuracy to the gauge and ensures a useful operating strategy for safety and performance.



Specs



	E40	E80	E175
Capacity	2048 Wh	4096 Wh	8960 Wh
Max Continuous Discharging Current	40 A	80 A	150A
Rated Voltage	51.2 V		
Final charging voltage	57.6 V		
Cut-off voltage	41.6 V		
Battery Life	3000 Cycles at 80% DOD		
Series Connection	×	×	×
Parallel Connection	Up to 16		
Charging Time (110V)	2 Hrs	4 Hrs	One charger: 9 Hrs Two chargers in parallel: 4.5 Hrs
Charging Time (220V)	2 Hrs	3 Hrs	One charger: 6 Hrs Two chargers in parallel: 3 Hrs
Weight	28 kg / 61.7 lbs	53 kg / 116.8 lbs	87 kg / 191.8 lbs
Dimensions	42 x 39 x 20.7 cm 16.5 x 15.4 x 8.2 inches	55.5 x 44 x 21.2 cm 21.9 x 17.3 x 8.4 inches	50 x 56.5 x 27.7 cm 19.7 x 22.2 x 10.9 inches
Recommended Model	 Spirit 1.0 Series, Pod Drive 1.0 Evo	 Navy 3.0 Evo, Pod Drive 3.0 Evo	 Navy 6.0 Evo, Pod Drive 6.0 Evo

Design

- 1 Discharge and charge port
- 2 Motor communication port
- 3 CAN communication port
- 4 State of charge indicator lights
- 5 Power button
- 6 Removable lift handle

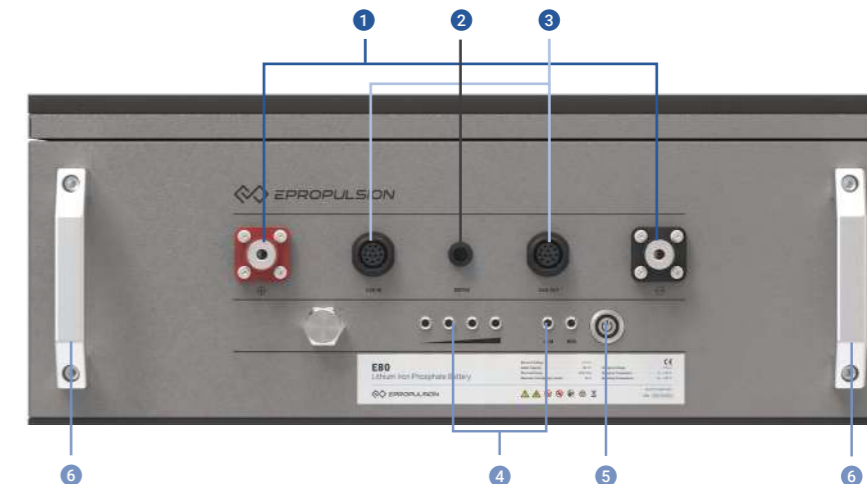

E-Series Battery Charger

Parallel Connection

Up to 8 units can be used in parallel connection. It's flexible enough to configure for a large capacity battery set.

Wide Input Voltage Range

From 85 VAC to 265 VAC. It's available to use worldwide.



* The charging power varies between different input voltages. At 220V, the output current is 30A. At 110V, approximately 20A.

E Battery External Display Panel

E Battery External Display Panel is used to connecting with E-Series Battery to show the information of the battery.





Vaquita Motor **1HP**

Made for Every SUP Paddler

Overview

Comfortable Speed

Equipped with a 300 W motor, the Vaquita takes a paddler up speed of 9 km/h or 5 knots. Traveling at that speed delivers a 70-minute runtime. Utilizing your Vaquita at half of the top speed means you'll have up to five hours of runtime.

Enjoy More Time on the Water

The Vaquita enables you go further and explore more, assisting you when you need it. The motor allows you paddle effortlessly and gives you the power to spend more time on the water.

Wireless Remote
The Vaquita features eight forward speeds, an LED indicator and an emergency stop function. It is simple and easy to use.

Indicator Lights
Stay informed of the battery status in real-time with 4 LED indicator lights.

Easy to Secure
The bottom of the battery has two buckles that offer you another option for securing your battery.

Overboard Protection
If you ever fall overboard, built-in sensors immediately stop the Vaquita motor.



Performance & Range

Vaquita - SUP	Speed (mph / kph)	Running Time (hh:mm)	Range (mile / km)
Slow Speed	2.6 / 4.2	8:00	20.9 / 33.6
Economical Speed	3.7 / 6	5:00	18.6 / 30
Full Speed	6.2 / 10	1:10	7.3 / 11.7

*Data above is tested with Red Paddle 10.6 Ride MSL. The actual speed, range and running time may vary due to different external conditions.

Specs

Running Time	70 min (full speed), 5 hr (half speed)	Battery Life	500 cycles at 80% DoD
Total Weight	4 kg	Motor Size	18.2 x 16.8 x 18.2cm / 7.2 x 6.6 x 7.2 inches
Adapters	US fin, SUP fin, Universal adapter	Battery Size	21.6 x 17.8 x 10 cm / 8.5 x 7 x 3.9 inches
Control	Wireless remote, 8 speeds forward	Battery Ingress Protection	IP67
Battery	324 Wh, Lithium-ion		

Lightweight & Portable

The Vaquita only weighs 4 kg. It's compact and easy to transport with our customized storage bag.





Accessories

Charger & Solar Panel

Vaquita Charger



Spirit 1.0 Plus
Charger



Spirit 1.0 Plus
12V Charger



Spirit 1.0 Plus Solar
Charger

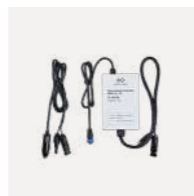

Spirit 1.0 Plus
Fast Charger



E Battery Charger
30A H



Control & Cable

Evo Dual Remote
Control

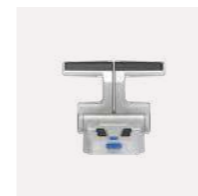

Safety
Wristband

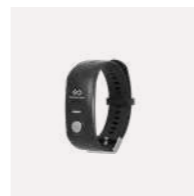

Communication
Cable 5m

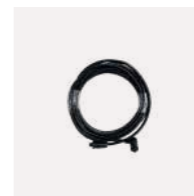

Spirit 1.0 Extension
Power Cable 2m



Communication
Extension Cable 5m



E Battery Communication
Cable 1.5m



Charger & Solar Panel

E Battery Charger
20A L



Foldable
Solar Panel



Control & Cable

Vaquita Remote Control



Evo Tiller



Evo Remote
Control



Evo Side Mount
Control

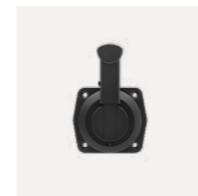

Control & Cable

E Battery Communication
Extension Cable 2m



0.5m Battery
Bridging Cable



1m Battery
Bridging Cable



2m Battery
Bridging Cable



E Battery Remote
Switch 5m



E Battery Communication
Terminator





Control & Cable

Spirit External
Battery Cable 1.5m



Spirit 1.0 Plus Extension
Power Cable 2m



Y Type Communication
Cable 0.3m



Connection Cable for
Pod 1.0 Evo and Spirit
Battery Plus 1m



Steering

Navy Accessory for
Seafirst Hydraulic
Steering System



Dual Motor
Link Arm



Propeller, Skeg, Anode

Spirit 1.0 Plus
Shaft Anode



Navy Anode



Navy Clamp
Anode

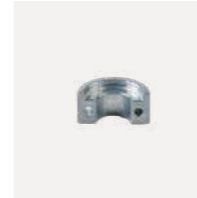

Navy Anticavitation
Plate



Navy 6.0 Evo
Anticavitation Plate



E Battery External
Display Panel



Propeller, Skeg, Anode

Pod 6.0 Evo Folding
Propeller



Pod 3.0 Evo Folding
Propeller



Pod 1.0 Evo Folding
Propeller

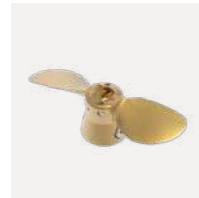

Spirit 1.0
Propeller

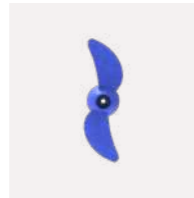

Navy 3.0
Propeller

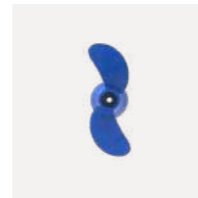

Navy 6.0 Low Pitch
Propeller

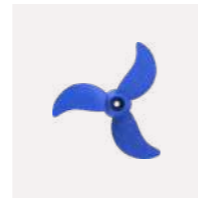

Extra

Spirit Battery Power
Output Set



Kill Switch
Assy

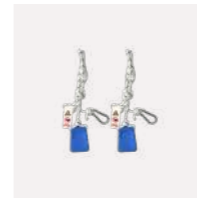

Spirit Motor
Cowling



Vaquita Carry
Bag



Spirit 1.0
Battery Bag



Spirit 1.0
Bag Set Plus



Propeller, Skeg, Anode

Navy 6.0 High Pitch
Propeller



Navy 6.0 Evo AL
Propeller

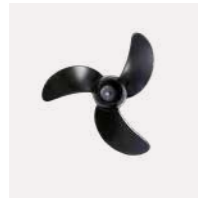

Pod 6.0 Evo
Propeller



Spirit 1.0 Evo
Clamp Anode



Spirit Clamp Base
Anode



Spirit 1.0 Plus
Motor Anode

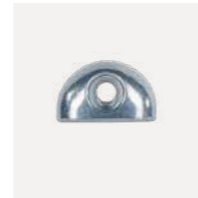

Extra

Spirit 1.0
Outboard Bag Plus





Recommended by Influencers and Specialists



Blake Yarter

- 3 Times Georgia State Bass Total Electric Champion
- Rutledge, GA, United States
- Blake Yarter

“ ePropulsion is hands down the leader of the electric outboard motor industry. The new Navy Evo 6.0 is virtually silent with smooth maneuverability and quicker hole shot. Top of the line technology sets it apart from its competitors. ”



Anthony Jones

- Jon Boat Fishing Specialist,
Father of Two Kids
- Georgia, United States
- Anthony Jones



Chris Gayton

- 2019 Georgia State Bass Total Electric Champion, Several Points Champion and Classic Champion of Small Water Angler Teams
- Cumming, Georgia, United States
- Chris Gayton

Apply for Pro Staff Program



The ePropulsion Pro Staff Program has been developed for the fishing market from 2021. We are looking for anglers who are active on social media and enthusiastic about electric outboard motors. For our Pro Staff team, we offer excellent rebates and opportunities to try out the latest products. Visit www.epropulsion.com/pro-staff for more information.

Empowering Fishing Enthusiasts

Jon Boat Bass Club of North Carolina

Headquartered in Butner NC, Jon Boat Bass Club of North Carolina (JBBCNC) is North Carolina's largest all-electric bass fishing organization, providing anglers of all skill levels the opportunity to compete. A new ePropulsion Invitational, presented by JBBCNC, will be taken place in 2022.

“ JBBCNC is pleased to kick start the partnership with ePropulsion. The evolution of all-electric bass trails has exploded across the Southern US. Anglers looking for an economical choice as well as the love of competition have found the all-electric format to be an outstanding opportunity to compete and enjoy likeminded anglers. ”

- Jeremy Roberts, JBBCNC Committee Chair



The Georgia Bass Total Electric Championship Invitational

The Georgia Bass Total Electric Championship Invitational (GA Bass TEC) is one of the largest electric only jon boat fishing tournaments in Georgia State. Top anglers from 9 major clubs and 36 teams participated in the 2019 competition.

“ When the electric only bass fishing sport originated it was typical to achieve speeds of three to four miles per hour. Now it may not seem drastic but these ePropulsion motors are reaching speeds nearly four times higher depending on the boat setup. The range of ePropulsion's motors when paired with lithium battery packs are much greater than the competition. Anglers can go longer distances at higher speeds with ePropulsion; leaving others in their wake. ”

- Merrick McClure, Director, ePropulsion GA Bass TEC





Online ePropulsion Owner Community

We connect and engage ePropulsion owners from all around the world through the Official ePropulsion Outboard Owners Facebook Group.

Join us and share your exciting electric boating moments with the worldwide ePropulsion customers. You will also get fast responses when you have questions about your ePropulsion products as well as staying updated on product upgrade and promotions.

Most active members will be recognized and be rewarded with souvenirs such as branded apparel and headwear.



Search [Official ePropulsion Outboard Owners](#) on Facebook



Ordering Information

MOTORS

PART NO	PRODUCT	DESCRIPTION
SPIRIT		
SP-0000-X1	Spirit 1.0 Plus Extra Shortshaft	3 HP direct drive electric outboard motor, including a 1276 Wh battery, an integrated tiller and a charger. Shaft length 52.5 cm / 20.7 inches.
SP-0000-S1	Spirit 1.0 Plus Shortshaft	Same as above with different shaft length 62.5 cm / 24.6 inches.
SP-0000-L1	Spirit 1.0 Plus Longshaft	Same as above with different shaft length 75 cm / 29.5 inches.
SP-1111-X1	Spirit 1.0 Plus Extra Shortshaft w/o Battery	3 HP direct drive electric outboard motor, including a tiller and a charger. Battery is excluded. Shaft length 52.5 cm / 20.7 inches.
SP-1111-S1	Spirit 1.0 Plus Shortshaft w/o Battery	Same as above with different shaft length 62.5 cm / 24.6 inches.
SP-1111-L1	Spirit 1.0 Plus Longshaft w/o Battery	Same as above with different shaft length 75 cm / 29.5 inches.
SE-TTTT-S0	Spirit 1.0 Evo Shortshaft	3 HP direct drive electric outboard motor featuring hydrogeneration, including a 1276 Wh battery, a detachable tiller and a charger. Shaft length 62.5 cm / 24.6 inches.
SE-TTTT-L0	Spirit 1.0 Evo Longshaft	Same as above with different shaft length 75 cm / 29.5 inches.
SE-RRRR-S0	Spirit 1.0 Evo Remote Shortshaft	3 HP direct drive electric outboard motor featuring hydrogeneration, including a 1276 Wh battery, a remote control, a charger and a remote kit. Shaft length 62.5 cm / 24.6 inches.
SE-RRRR-L0	Spirit 1.0 Evo Remote Longshaft	Same as above with different shaft length 75 cm / 29.5 inches.
SE-1111-S0	Spirit 1.0 Evo Motor Body Shortshaft	3 HP direct drive electric outboard motor featuring hydrogeneration. Battery and controller are excluded. Shaft length 62.5 cm / 24.6 inches.
SE-1111-L0	Spirit 1.0 Evo Motor Body Longshaft	Same as above with different shaft length 75 cm / 29.5 inches.
SE-R999-00	Spirit 1.0 Evo Remote Kit	This remote kit helps you turn a Spirit 1.0 Evo motor into a remote version that works with a steering wheel.
NAVY		
NE-3000-S0	Navy 3.0 Evo Shortshaft	6 HP direct drive electric outboard motor featuring hydrogeneration. Battery, controller and charger are excluded. Shaft length 64 cm / 25.2 inches.
NE-3000-L0	Navy 3.0 Evo Longshaft	Same as above with different shaft length 76.5 cm / 30.1 inches.
NE-6000-S0	Navy 6.0 Evo Shortshaft	9.9 HP direct drive electric outboard motor featuring hydrogeneration. Battery, controller and charger are excluded. Shaft length 64 cm / 25.2 inches.
NE-6000-L0	Navy 6.0 Evo Longshaft	Same as above with different shaft length 76.5 cm / 30.1 inches.

PART NO	PRODUCT	DESCRIPTION
POD		
P1-0000-E0	Pod Drive 1.0 Evo	3 HP direct drive electric pod drive motor featuring hydrogeneration. Battery, controller and charger are excluded.
P3-0000-E0	Pod Drive 3.0 Evo	6 HP direct drive electric pod drive motor featuring hydrogeneration. Battery, controller and charger are excluded.
P6-0000-E0	Pod Drive 6.0 Evo	9.9 HP direct drive electric pod drive motor featuring hydrogeneration. Battery, controller and charger are excluded.

VAQUITA		
VA-0000-00	Vaquita SUP Motor	1 HP direct drive electric SUP motor, including a 324 Wh battery, a remote control and a charger.

BATTERIES

PART NO	PRODUCT	DESCRIPTION
SP-B000-02	Spirit Battery Plus	1276 Wh / 48V lithium battery for Spirit 1.0 Plus, Spirit 1.0 Evo and Spirit 1.0R Evo. Lightweight, safe and floatable.
EB-0040-00	E40 Battery	2048 Wh / 48V LiFePO4 battery with 3000 cycles of battery life. High energy density in a compact size. Affordable, safe and durable.
EB-0080-00	E80 Battery	4096 Wh / 48V LiFePO4 battery with 3000 cycles of battery life. High energy density in a compact size. Affordable, safe and durable.
EB-0175-00	E175 Battery	8960 Wh / 48V LiFePO4 battery with 3000 cycles of battery life. High energy density in a compact size. Affordable, safe and durable.
VA-B000-00	Vaquita Battery	324 Wh / 24V lithium battery for Vaquita SUP motor. Lightweight and compact.

CONTROLLERS

PART NO	PRODUCT	DESCRIPTION
NE-TC00-00	Evo Tiller	Detachable tiller with integrated display monitoring real-time motor / battery status, for Spirit Evo models and Navy Evo models.
NE-RC00-00	Evo Remote Control	Wireless remote controller with integrated display monitoring real-time motor / battery status, for Spirit 1.0R Evo, Navy Evo models and Pod Evo models.
NE-SM00-00	Evo Side Mount Control	Smart side mount controller with independent display monitoring real-time motor / battery status, for Spirit / Navy / Pod Evo models.
NE-DR00-00	Evo Dual Remote Control	Remote control for twin installation of Spirit / Navy Evo motors. independent display monitors real-time status of power and each motor.
VA-RC00-00	Vaquita Remote Control	Wireless remote control for Vaquita SUP motor. 8 forward speeds. Overboard protection.

ACCESSORIES

PART NO	PRODUCT	DESCRIPTION
CHARGERS & SOLAR PANEL		
VA-C000-00	Vaquita Charger	180 watts charger for Vaquita Battery. Input voltage (AC): 100 V ~ 240 V. Max output voltage (DC): 25.2 V
SP-C001-00	Spirit 1.0 Plus Charger	180 watts charger for Spirit Battery Plus. Input voltage (AC): 100 V ~ 264 V. Max output voltage (DC): 52.2 V
SP-C002-00	Spirit 1.0 Plus 12V Charger	70 watts DC / DC charger, allowing the Spirit 1.0 Plus Battery to be charged from a 10 V ~ 30 V power source.
SP-C003-00	Spirit 1.0 Plus Solar Charger	180 watts solar charger, allowing the Spirit Battery Plus to be charged with solar energy (solar panel excluded).
SP-C004-02	Spirit 1.0 Plus Fast Charger	520 watts charger, taking 3 hours to charge a Spirit Battery Plus from empty to full. Input voltage (AC): 100 ~ 240 V.
EC-0030-20	E Battery Charger 30A H	Same as above with different input voltage (AC) 90 ~ 132 V.
EC-0020-11	E Battery Charger 20A L	For E40, E80 and E175. Max output current (110V): approx. 20A. Parallel connection: max 8 units
FS-P000-00	Foldable Solar Panel	100 watts foldable solar panel, portable and efficient, with plug & play waterproof connectors, designed for Spirit Battery Plus.

CABLES

00-0601-01	Communication Cable 5m	Connect a motor and a controller or a motor and an E-series battery for more accurate data transmission.
00-0601-03	Communication Extension Cable 5m	Extend the 5m communication cable for extra 5 meters to allow wired operation from a longer distance.
00-0601-10	E Battery Communication Cable 1.5m	A 1.5m communication cable used for parallel connection between E-Series batteries.
00-0601-11	E Battery Communication Extension Cable 2m	A 2m communication cable that extends the parallel connection distance between E series batteries.
EB-AC02-00	E Battery Remote Switch 5m	This switch with a 5m cable allows you to switch on/off paralleled E-series batteries in a distance. It connects to the CAN-IN port on an E-series battery.
EB-AC01-00	E-Series Battery Communication Terminator	This is a required item for the parallel connection of E-Series batteries. It connects to the CAN-IN port on the master battery.
00-0601-08	Spirit External Battery Cable 1.5m	This cable allows you to connect the Spirit 1.0 Plus/Evo motor with a 48V E-Series Battery to extend range.
S1-CM03-00	Spirit 1.0 Extension Power Cable 2m	It connects the Spirit Battery and the Spirit 1.0 motor, allowing you to place the battery 2 meters from the motor.
00-0601-09	Spirit 1.0 Plus Extension Power Cable 2m	It connects the Spirit Battery Plus and the Spirit 1.0 Plus/Evo motor, allowing you to place the battery 2 meters from the motor.

PART NO	PRODUCT	DESCRIPTION
00-0601-12	Y Type Communication Cable 0.3m	A communication cable with one male connector and two female connectors, allowing you to connect both the controller and the E-Series batteries to an ePropulsion motor.
00-0601-25	Connection Cable for Pod 1.0 Evo and Spirit Battery Plus 1m	It connects the Spirit Battery Plus and the Pod Drive 1.0 Evo.
00-0601-28	0.5m Battery Bridging Cable	For E-Series battery parallel and series connection
00-0601-29	1m Battery Bridging Cable	For E-Series battery parallel and series connection
00-0601-30	2m Battery Bridging Cable	For E-Series battery parallel and series connection

STEERING

N6-AC01-00	Navy Accessory for Seafirst Hydraulic Steering System	It connects Navy Evo and the Seafirst steering Hydraulic cylinder
00-0800-02	Dual Motor Link Arm	For dual-engine steering

PROPELLERS, SKEGS, ANODES

S1-M001-00	Spirit 1.0 Propeller	11" x 5.8" 2-blade composite propeller, applies to Spirit 1.0 Plus/Evo.
SE-TB01-00	Spirit 1.0 Evo Clamp Anode	Applies to Spirit Plus manufactured since 2022 and Spirit Evo.
S1-TB02-05	Spirit 1.0 Clamp Base Anode	Applies to all Spirit outboards.
SP-M013-00	Spirit 1.0 Plus Motor Anode	Applies to Spirit 1.0 Plus/Evo.
SP-M012-00	Spirit 1.0 Plus Shaft Anode	Applies to Spirit 1.0 Plus/Evo.
N3-LU05-00	Navy 3.0 Propeller	10.2" x 6.7" 2-blade composite propeller.
N6-LU02-00	Navy 6.0 Low Pitch Propeller	13.4" x 8.5" 3-blade composite propeller.
N6-LU12-00	Navy 6.0 High Pitch Propeller	12.6" x 10.8" 3-blade composite propeller.
N6-LU01-E0	Navy 6.0 Evo AL Propeller	12.6" x 8.7" 3-blade aluminum propeller.

PART NO	PRODUCT	DESCRIPTION
N6-AP00-E0	Navy 6.0 Evo Anticavitation Plate	Avoid vaporized air caused by water flow disturbances. Made of high-strength aluminum alloy.
N6-TB11-00	Navy Clamp Anode	Sacrificing itself to protect the surface of the outboard from corroding, applies to Navy Evo, double inner-side of clamp.
N6-AP00-00	Navy Anticavitation Plate	Avoid vaporized air caused by water flow disturbances. Made of high-strength aluminum alloy.
N6-LU01-00	Navy Anode	Sacrificing itself to protect the surface of the outboard from corroding, applies to Navy Evo, outside of the propeller shaft.
P6-M001-00	Pod 6.0 Evo Propeller	12.6" x 8.7" 3-blade aluminum propeller.
P6-LU01-00	Pod 6.0 Evo Folding Propeller	12" x 21.3" 2-blade NAB folding propeller.
P3-LU01-E0	Pod 3.0 Evo Folding Propeller	9.96" x 6.34" 2-blade NAB folding propeller
P1-LU01-E0	Pod 1.0 Evo Folding Propeller	9.96" x 6.34" 2-blade NAB folding propeller

EXTRAS

VA-BG00-00	Vaquita Carry Bag	Transport and store a complete Vaquita kit. Dust-resistant and washable.
S1-BG00-01	Spirit 1.0 Bag Set Plus	Made for easy transportation and storage of a Spirit outboard and a Spirit battery.
S1-BG01-01	Spirit 1.0 Outboard Bag Plus	Transport and store a Spirit motor. Dimension: 48.8 x 7.8 x 16.5 inches / 124 x 20 x 42 cm
S1-BG02-00	Spirit 1.0 Battery Bag	Transport and store a Spirit battery. Dimension: 11.8 x 7.8 x 16.5 inches / 30 x 20 x 42 cm
SP-M005-00	Spirit Motor Cowling	If a Spirit motor works with an E-Series battery, the original Spirit battery is removed. This cowling is put on the top for decoration purpose.
S1-TH02-00	Kill Switch Assy.	Shut down the motor upon the removal of this magnetic kill switch. A safety lanyard is included.
NE-SW00-00	Safety Wristband	IP67 wireless wristband works with Evo Tiller / Evo Remote Control. Shut down the motor in accidents. Max connection up to 8 units.
EB-DP00-00	E Battery External Display Panel	Display panel for E-Series battery
S1-BA01-00	Spirit Battery Power Output Set	It is working with the Spirit battery activator to power other appliances

Follow ePropulsion on

